



8-hole harness connector

8-hole harness connector DJ7081-6.3-20

Material: nylon PA6

Flame retardant rating: 94V-0

Working frequency: high frequency

Interface Type: IDC

Line length: 500mm

Features: Waterproof

Uses: Widely used in the automotive industry

The whole set of corresponding male shell: DJ7081-6.3-10

The corresponding set of male terminals: DJ612-A6.3

Complete sets of corresponding female terminals: DJ621-B6.3

Note: can be a single order, but also the entire order.



Car connector multi-core connector plastic pieces of plastic shell

Specification

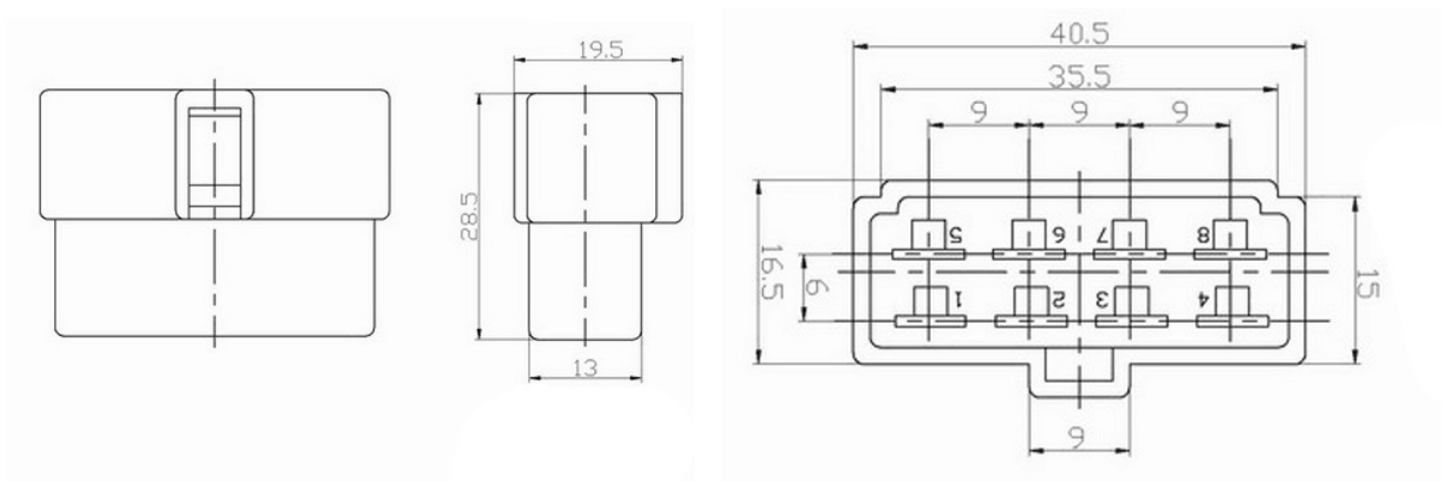

Product Show

